

Lucht-lucht
warmtepompen
voor thuisgebruik

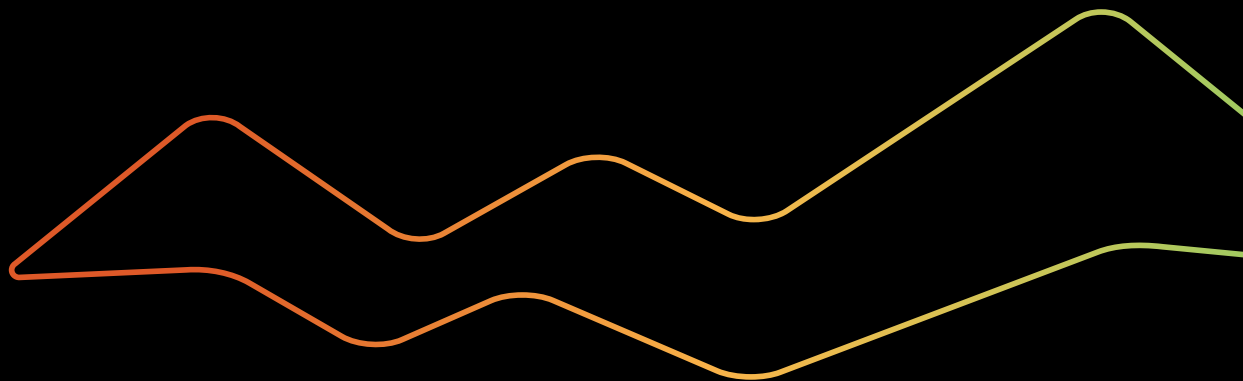



RAC-Solo: Stand-alone Airconditioning
Een compacte airconditioner, zonder buitenunit.



Eén systeem, in een elegante binnenunit

- Robuust, modern design door metalen frame.
- Flexibele mogelijkheden met eenvoudige installatie.
- Uitermate geschikt voor monumentale panden of waar beperkte ruimte beschikbaar is.

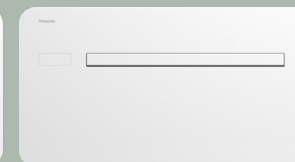
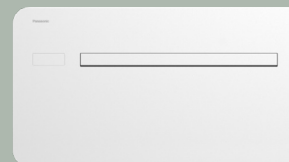
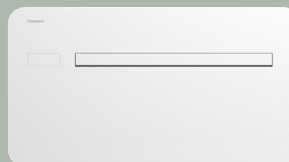
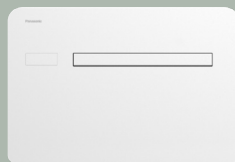

Productcode	P-MOG16IC5-E	P-MOG20IC5-E	P-MOG25IC5-E	P-MOG30IC5-E
Verwarmings capacity ¹ (kW) Nominaal/ Max	1,71 / 2,40	2,08 / 2,64	2,31 / 3,05	2,75 / 3,5
Koel capaciteit ² (kW) Nominaal/ Max	1,73 / 2,35	2,09 / 2,64	2,33 / 3,10	2,87 / 3,5
Koudemiddel	R290	R32	R32	R32
Afmetingen mm (HxBxD)	810x549x165	1010x546x165	1010x546x165	1010x546x165
Diameter opening buiten mm	162	162	162	202



1) Verwarming bij A7 A20 2) Koelen bij A35 A27

- 1 Volledig metalen behuizing**
De behuizing is volledig gemaakt van metaal. Sterk en robuust.
- 2 Touchscreen en Wi-Fi-ontvanger**
Met het grote bedieningspaneel kunt u elke bedrijfsparameter selecteren en ook de communicatie via Wi-Fi beheren.
- 3 Hoog efficiënt condensatie batterij**
De condensor batterij heeft een hoog rendement met een verdampingscondensatiesysteem voor nog betere prestaties.
- 4 Supercompact ontwerp**
Een supercompacte behuizing bevat alles wat nodig is voor de perfecte werking van het product dankzij nauwgezet ontwerp en studiewerk met als doel de grootte van elk onderdeel te verkleinen en de perfecte werking ervan te garanderen.

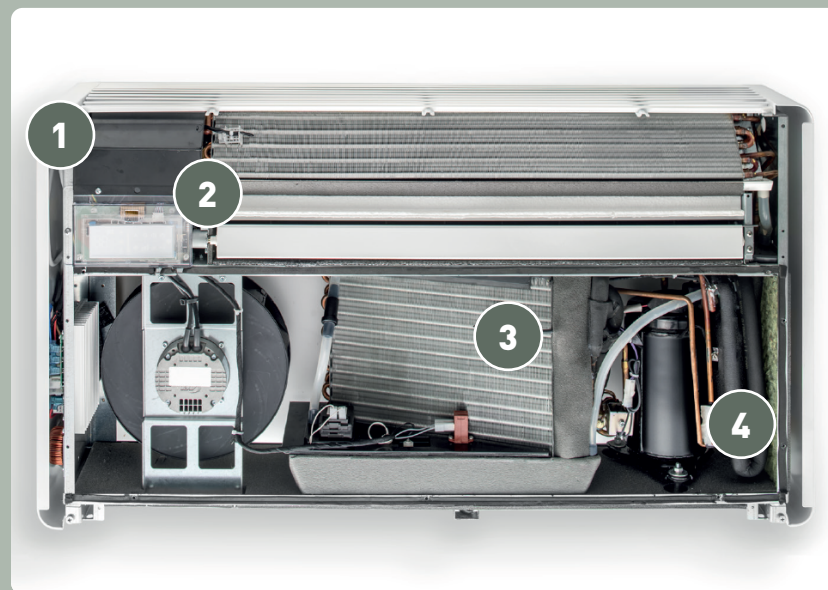

Ontworpen voor eenvoudige installatie

- A** Unit geïnstalleerd aan de muur.
- B** Twee kanalen (max. lengte 1 m).
- C** Afdekrooster voor buiten.

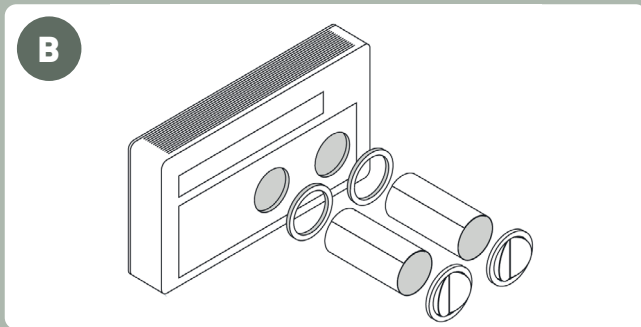

Diameter is 162 mm



Diameter is 202 mm voor grootste type



Installatie aan zijwand

In het geval dat de buitenmuur zijdelings ten opzichte van de unit ligt, is installatie mogelijk met behulp van de 'Zij installatie kit'.

In dit geval zijn de kit en het apparaat in de muur verwerkt.



Aansluitsets

Er zijn zowel linkse als rechtse aansluitsets beschikbaar.

- Rechter kit: PCZ-L00773
- Linker kit: PCZ-L00773

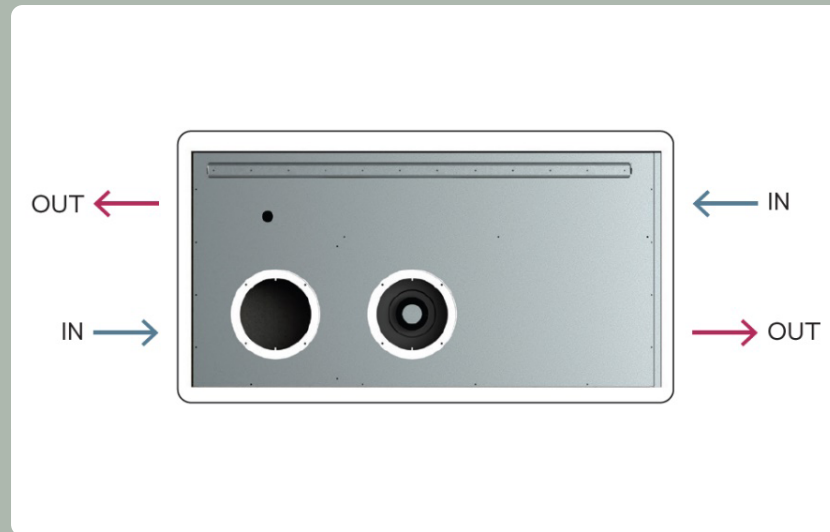

Lucht-lucht warmtepompen voor iedere woning.

Panasonic Single Split Buitenunits.

- Buitendelen met vermogens tussen de 2 kW en 7,1 kW.
- Ingebouwde WiFi.
- Hoge efficiëntie.

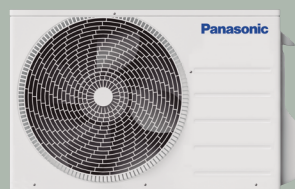

CU-*Z20CKE
CU-*Z25CKE
CU-*Z35CKE
CU-*Z42CKE
CU-Z25CBEA

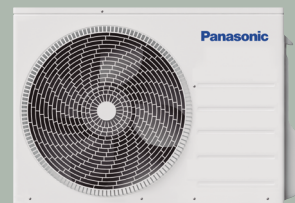

CU-BZ50CKE
CU-TZ50CKE
CU-TZ60CKE
CU-Z35CBEA

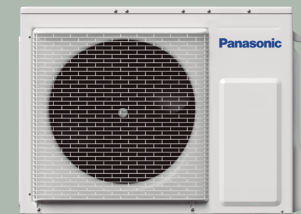

CU-BZ60CKE
CU-TZ71CKE
CU-Z50CKE
CU-Z71CKE
CU-Z50CBEA
CU-Z60CBEA



Panasonic Single Split Binnenunits.

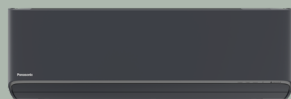

CS-XZ**CKEW-H

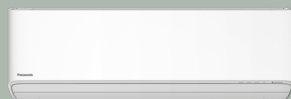

CS-Z**CKEW

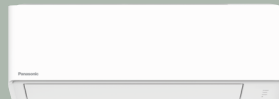

CS-TZ**CKEW



CS-BZ**CKE



CS-Z**CFEAW



NIEUW!

Luchtkwaliteit

- nanoe™ X Generator Mark 3.
- Ontgeurt, hydrateert en remt vervuiling.
- Interne reinigingsfunctie die stof en schimmelmicrobiële groei tegen gaat.

Smart Control

- **NIEUW!** AI ECO-modus. Leert de omstandigheden in de ruimte en balanceert tussen energie besparen en sneller koelen.
- Ingebouwde Wi-Fi.
- Bediening via de Panasonic Comfort Cloud.

Hoge Energie Efficiëntie

- Hoge SEER/SCOP (9.5/5.2)*1

Hoger Comfort

- Bedrijfsbereik van verwarming tot -20°C.
- Aerowings 2.0.
- Fluïsterstil 19 dB(A).

Design

- Stijlvol design, beschikbaar in 2 kleuren.
- Afstandsbediening in stijl van de binneneenheid.*2

Eenvoudige Installatie en Service

- Chassis en onderdelen ontworpen voor een eenvoudigere installatie.

*1 2.5, 3.5 kW modellen

*2 CS-XZ**CKEW-H

ETHEREA

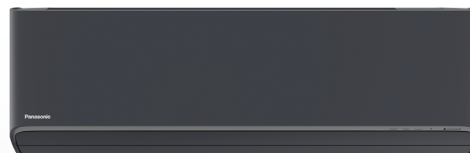

CS-XZ**CKEW-H

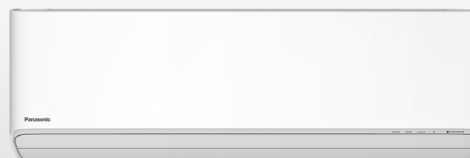

CS-Z**CKEW



9.5 SEER



5.2 SCOP



*Afbeeldingen zijn voor de 1.6-4.2 kW modellen.



Wit	CS-MZ16ZKE	CS-Z20CKEW	CS-Z25CKEW	CS-Z35CKEW	CS-Z42CKEW	CS-Z50CKEW	CS-Z71CKEW
Grafiët grijs	-	CS-XZ20CKEW-H	CS-XZ25CKEW-H	CS-XZ35CKEW-H	CS-XZ42CKEW-H	-	-
Capaciteit	1.6 kW	2.0 kW	2.5 kW	3.5 kW	4.2 kW	5.0 kW	7.1 kW
Binneneenheid afmetingen (mm)	290 x 870 x 229				295 x 1.040 x 244		
Model	-*	CU-Z20CKE	CU-Z25CKE	CU-Z35CKE	CU-Z42CKE	CU-Z50CKE	CU-Z71CKE
Buiteneenheid afmetingen (mm)	-	542 x 780 x 289				695 x 875 x 320	
Energieklasse	-	A+++ / A++	A+++ / A+++		A++ / A+	A+++ / A++	A++ / A+

*Enkel in combinatie met multisplit buiteneenheden.



NIEUW!

Luchtkwaliteit

- **NIEUW!** nanoe™ X Generator Mark 2.
- Ontgeurt, hydrateert en gaat de groei van 5 type vervuilers tegen.

Smart Control

- Geavanceerde, ingebouwde Wi-Fi.
- Bediening via de Panasonic Comfort Cloud.
- Google Assistant en Amazon Alexa compatibiliteit.

Hoge Energie Efficiëntie

- **NIEUW!** Hoge SEER/SCOP (7.3/4.6)*

Hoger Comfort

- Aerowings.
- Fluïsterstil 20 dB(A)*.

Makkelijke Installatie en Service

- **NIEUW!** Eenvoudige installatie en onderhoud 2.0.

Super Compact Design

- **NIEUW!** Nu nog smaller!
Slechts 765 mm breed.



*Afbeelding 1.6-5.0 kW model



*2,5 kW model.

Model	CS-MTZ16ZKE	CS-TZ20CKEW	CS-TZ25CKEW	CS-TZ35CKEW	CS-TZ42CKEW	CS-TZ50CKEW	CS-TZ60CKEW	CS-TZ71CKEW
Capaciteit	*1.6 kW	2.0 kW	2.5 kW	3.5 kW	4.2 kW	5.0 kW	6.0 kW	7.1 kW
Binnenunit afmetingen (mm)	290 x 765 x 214						295 x 1.060 x 249	
Model	-*	CU-TZ20CKE	CU-TZ25CKE	CU-TZ35CKE	CU-TZ42CKE	CU-TZ50CKE	CU-TZ60CKE	CU-TZ71CKE
Buitenunit afmetingen (mm)	-	542 x 780 x 289				619 x 824 x 299		695 x 875 x 320
Energieklasse	-	A++/A++			A++/A+			

*Enkel in combinatie met multisplit buitenunits.



NIEUW!

Luchtkwaliteit

- **NIEUW!** nanoe™ X Generator Mark 3.
- Ontgeurt, hydrateert en gaat de groei van 5 type vervuilers tegen.

Super Compact Design

- Binnenunit is 750 mm breed.

Hoge Energie Efficiëntie

- Hoge SEER/SCOP (8.1/4.6)*

Hoger Comfort

- Fluïsterstil 19 dB(A).

Makkelijke Installatie en Service

- Eenvoudige installatie toegepast op chassis en onderdelen.

Smart Control

- **NIEUW!** Ingebouwde WiFi voor eenvoudige bediening
- **NIEUW!** Stijlvolle afstandbediening.
- Google Assistant en Amazon Alexa compatibiliteit.
- Bediening via de Panasonic Comfort Cloud.



*Afbeelding 1.6-5.0 kW model



Model	CS-MZ20CFEA	CS-Z25CFEAW	CS-Z35CFEAW	CS-Z50CFEAW
Capaciteit	2,0 kW	2,5 kW	3,5 kW	5 kW
Binnenunit afmetingen (mm)	600 x 750 x 207			
Model	-*	CU-Z25CBEA	CU-Z35CBEA	CU-Z50CBEA
Buitenunit afmetingen (mm)	-	542 x 780 x 289	619 x 824 x 299	695 x 875 x 320
Energieklasse	A++			

*3,5 kW model.

*Enkel in combinatie met multisplit buitenunits.



NIEUW!

NIEUW! Ingebouwde Wi-Fi voor slimme bediening

- Eenvoudige verbinding met de app met behulp van QR-code.
- Werkt met Google Home en Alexa.

Betere luchtkwaliteit

- Schonere binnenlucht met PM2,5 filter.

Grote flexibiliteit

- **NIEUW!** Supercompacte binnenunit, slechts 765 mm breed.
- **NIEUW!** Eenvoudige installatie en onderhoud 2.0.

Maximaliseren van comfort

- Aerowings.
- Superstille werking: slechts 20 dB(A).

A++

6.4 SEER

A+

4.2 SCOP

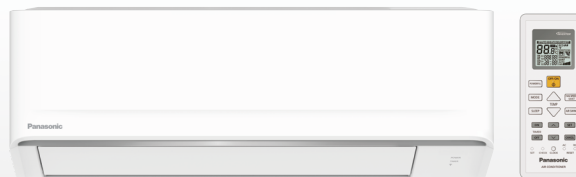

CS-BZ**CKE



Model	CS-BZ25CKE	CS-BZ35CKE	CS-BZ50CKE	CS-BZ60CKE
Capaciteit	2,5 kW	3,5 kW	5,0 kW	6,0 kW
Binnenunit afmetingen (mm)	290 x 765 x 214			
Model	CU-BZ25CKE	CU-BZ35CKE	CU-BZ50CKE	CU-BZ60CKE
Buitenunit afmetingen (mm)	542 x 780 x 289		619 x 824 x 299	695 x 875 x 320
Energieklasse	A++ / A+			

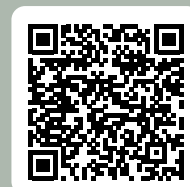

Panasonic Free Multi Buitenunit

- Werkbereik tot -25 °C.
- Uitgerust met condensbakverwarming.
- Hoge energie-efficiëntie: SCOP van 4,60.
- Ethernano™ X-technologie voor betere bescherming 24/7.
- Compatibel met:



- Capaciteit 2 tot 5 kW.

Outdoor Unit Ontwerp



CU-2Z50ABEC - CU-3Z75ABEC

CU-2Z50ABEC



8.0 SEER



4.4 SCOP

CU-3Z75ABEC



8.0 SEER



4.6 SCOP



Model	CU-2Z50ABEC	CU-3Z75ABEC
Te verbinden capaciteit binnenunit	0,85 - 3,6 kW	0,85 - 7,5kW
Buitenunit afmetingen (mm)	795 x 875 x 320	
Gewicht (kg)	58	62
Ruimtes	2	3
Energieklasse	A++	A++



Combineer meerdere binnenunits met één buitenunit

Panasonic Free Multi Buitenunits

- Beschikbaar 2, 3, 4 en 5-poorts units.*
- Buitendelen met vermogens tussen de 3.5 kW en 9 kW.
- Hoge efficiëntie.
- 5 binnendelen aansluitbaar.
- Slechts één buitenunit nodig voor meerdere ruimtes.

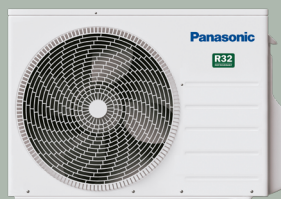

CU-2Z35CBE
CU-2Z41CBE
CU-2Z50CBE

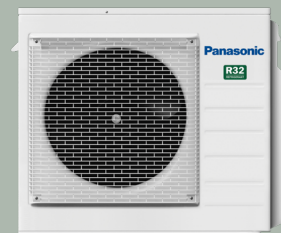

CU-3Z52CBE
CU-3Z68CBE
CU-4Z68CBE

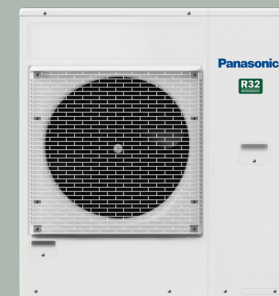

CU-4Z80CBE
CU-5Z90CBE



Te combineren binnenunits

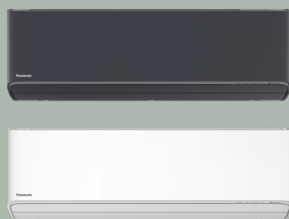

CS-MZ16CKE
CS-(X)Z**CKEW(-H)

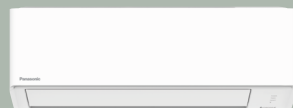

CS-MTZ16CKE
CS-TZ**CKEW



CS-MZ20CFEA
CS-Z**CFEAW



CS-MZ20CD3EA
CS-Z**CD3EAW



S-M20PY3E
S-**PY3E



Met onze gebruiksvriendelijke interface kunt u uw airconditioners op uw gemak bewaken en bedienen.

Scan de QR code en bekijk het filmpje

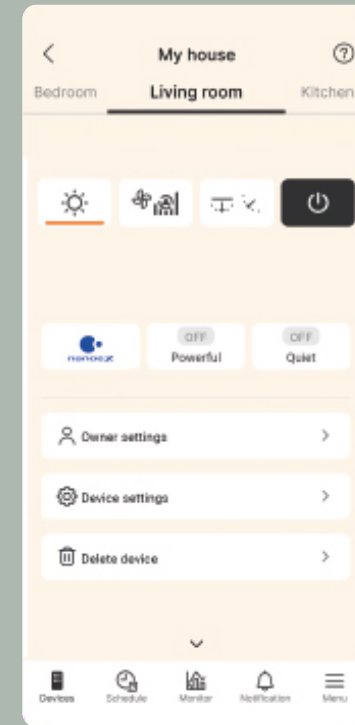
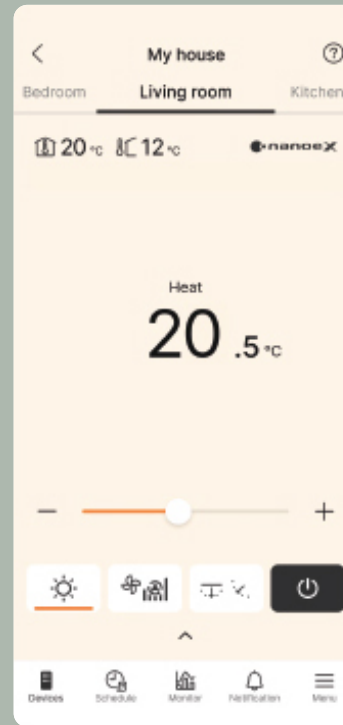

<p>Vereisten voor verbinding maken met Panasonic Comfort Cloud-app</p>	<p>Indoor Unit-Netwerk Binneneunit uitgerust met ingebouwde Wi-Fi /CZ-TACG1</p>	<p>Andere hardwarevereisten* Router - Internet - Smartphone (Vereist 2,4 GHz transmissiekanaal)</p> <p><small>*Afzonderlijk aanschaffen en abonneren</small></p>	<p>Download gratis app Compatibel Apparaat en browsers.</p> <p>1. iOS 9.0 of hoger 2. Android™ 5.0 Lollipop of later</p>
---	--	---	---



Illustraties van app-schermen kunnen afwijken van de werkelijke schermweergave.

nanoeTM X

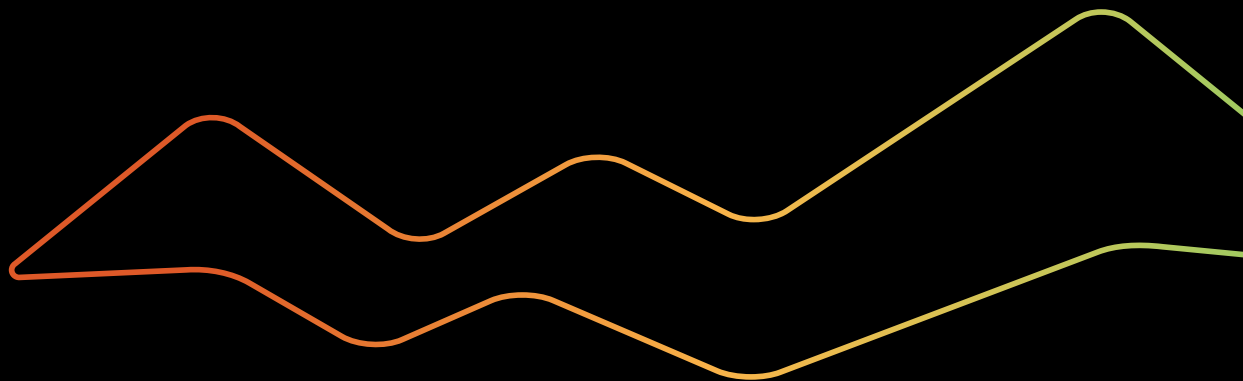



De kracht van nanoe™ X.

- Natuurlijke moleculen die lucht zuiveren en schadelijke stoffen afremmen en neutraliseren.
- Verbeterd binnenklimaat.
- Al 20 jaar bewezen technologie.



7 effecten van nanoe™ X.

Ontgeuren.

Mogelijkheid om 5 typen vervuilers te remmen/stoppen.

Hydrateren.



Nare geurtjes



Bacteriën & virussen



Schimmels



Allergenen



Pollen



Gevaarlijke stoffen



Huid & Haar

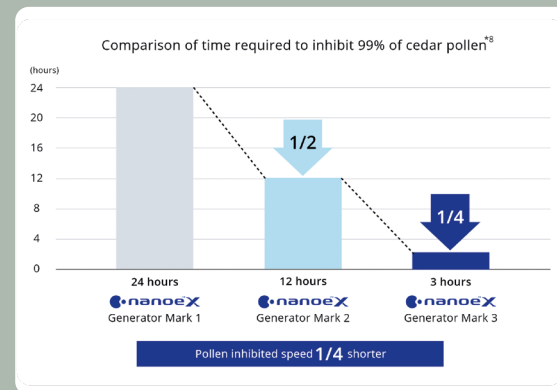

Hoge kwantiteit

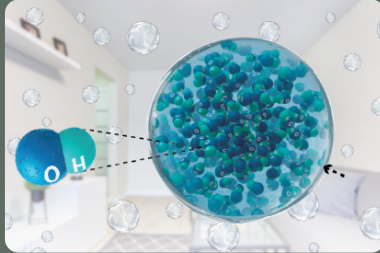

nanoe™ X produceert 48 triljoen hydroxylradicalen per seconde. Grote hoeveelheden hydroxylradicalen in nanoe™ X leiden tot uitstekende effecten in het remmen van vervuilers.

Lang werkzaam

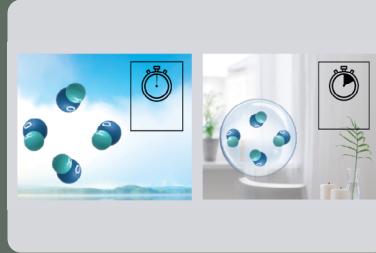

nanoe™ X-technologie maakt hydroxylradicalen in water, waardoor hun dan een seconde naar meer dan 600 seconden (10 minuten) stijgt, waardoor het zich over een grote afstand kan verspreiden.

Actieve ruimtevulling

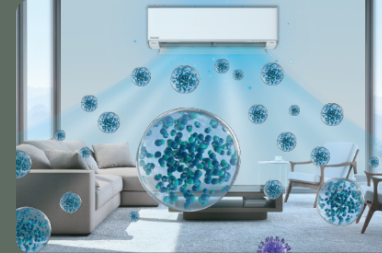

nanoe™ X vult ruimtes actief en gaat vele malen verder dan de effecten van een filter om vervuilers tegen te gaan.

Onderhoudsvrij

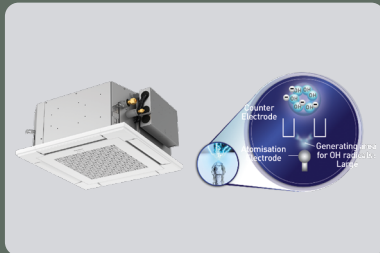

Er is geen onderhoud vereist. nanoe™ X is een filtervrije oplossing die gebruik maakt van een atomiseerde elektrode van titanium, waardoor onderhoud overbodig is.

Effectief op stof & oppervlakten

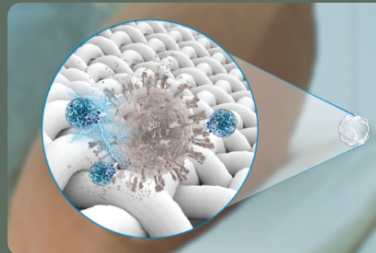

Met een formaat nog kleiner dan een stoomdruppel, kan nanoe™ X stoffen diep binnendringen om ze effectief te kunnen ontgeuren.

Veilig te gebruiken



De veiligheid van nanoe™ X is in verschillende labs en instituten getest.







Etherea Graphite
nanoe™ X Mark 3



Etherea Pure White
nanoe™ X Mark 3



Vloermodel
nanoe™ X Mark 3



TZ Wandmodel
nanoe™ X Mark 2



Standalone air-e nanoe™ Generator
nanoe™ X Mark 1





Volg ons op LinkedIn.



PRO Club

Altijd alle productinfo
bij de hand, laatste updates
in je inbox en toegang
tot handige tools?
Word dan lid van de PRO Club.

